

Data Sheet



Article number: 20302316

Description: E+G Handwheel
DIN 950-AL-160-B16-A

Measures

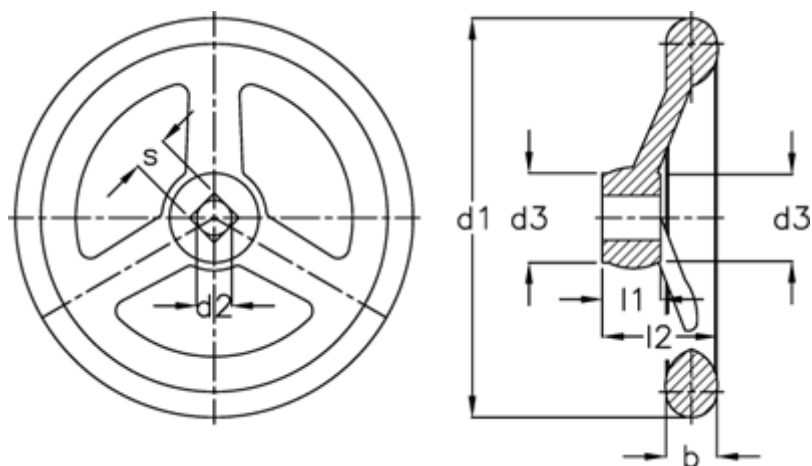

b	= 18
d1	= 160
d2 H7	= 16
d3	= 33
l1	= 20
l2	= 40
Number of spokes	= 3